

32"

aiolec[®]

CD COMMERCIAL DISPLAYS

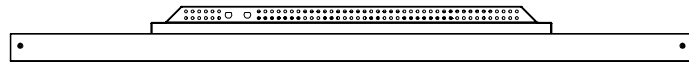

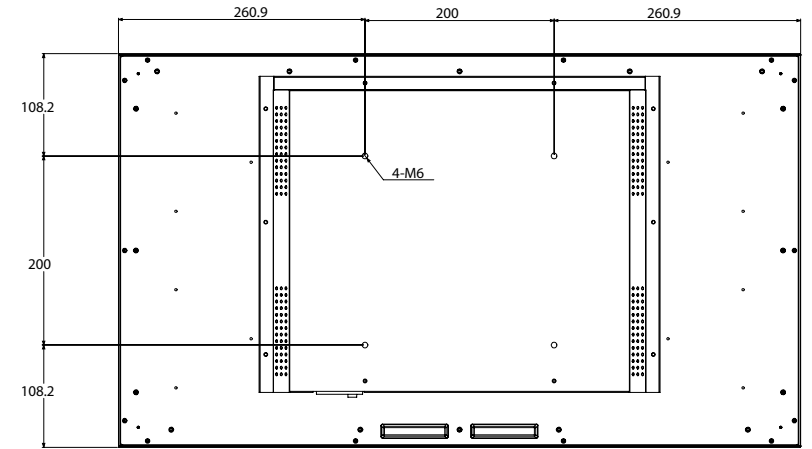
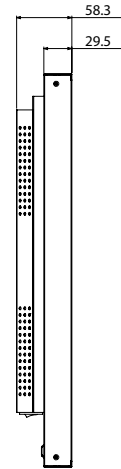
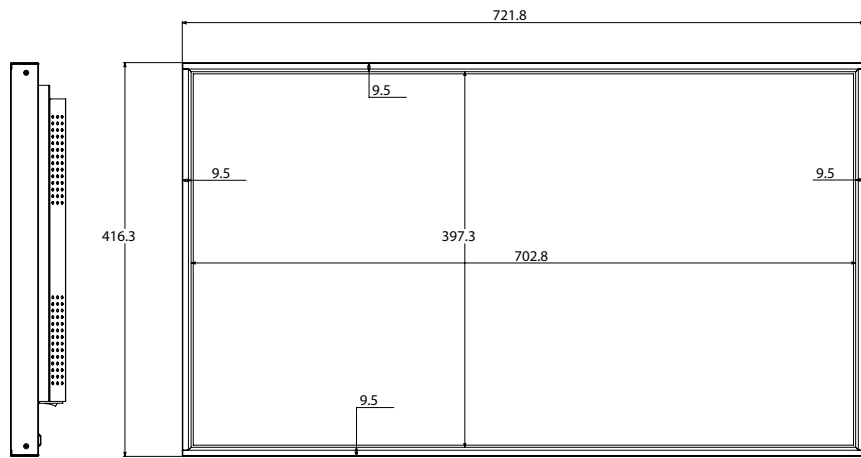
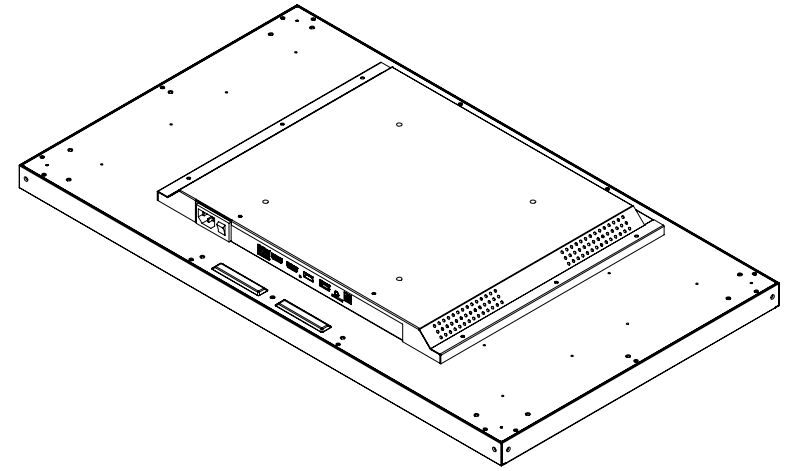
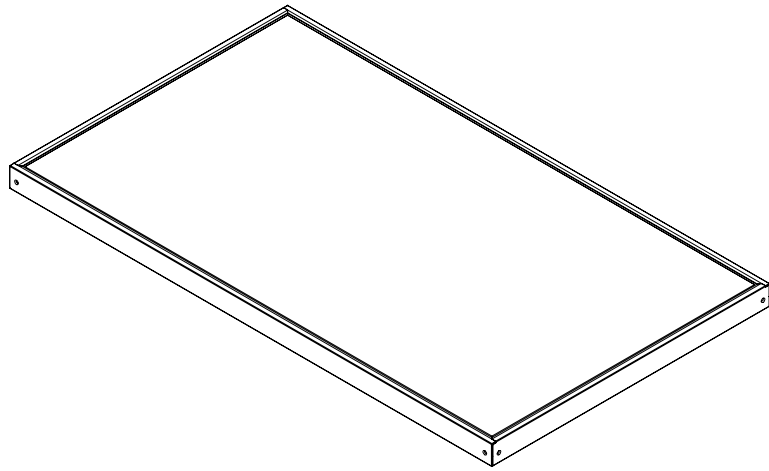

CD COMMERCIAL DISPLAYS

Technical Specifications

Hardware Specifications	
CPU	RK3576 , octa-core CPU, big and small core architecture (Quad-Core Cortex-A72 + Quad-Core Cortex-A53) , main frequency up to 2.2 GHz
GPU	3D GPU fully compatible with OpenGL ES1.1, 2.0 and 3.2, OpenCL up to 2.0 and Vulkan 1.1
NPU	RKNN NPU, 6TOPS computing power NPU
Storage Configuration	Standard configuration : 2GB + 32GB , 4GB + 32GB , 4GB + 64GB
Network	Support RJ45 R/A Gigabit Ethernet, support Ethernet ; support PoE power supply; Support 2.4GHz+5GHz Wi-Fi 6 ; support Wi-Fi 802.11 b/g/n/ax protocol; Supports Bluetooth 5.3
Image Rotation	Supports 0, 90, 180, and 270 degree manual rotation; optional gravity sensor to support automatic rotation
Display Interface	1*LVDS, support 1920*1080@60Hz; 1* HDMI OUT, support 4096*2160@120Hz; 1*V-by-One, support 3840@2160@60Hz; 1 *MIPI_DSI 2560*1600@60Hz Onboard backlight control supports 12V backlight power supply Note: Only one of LVDS/V-by-One/HDMI OUT can be selected..
Audio	Support standard left and right channel line output; support 3.5mm audio output interface
Amplifier	2-way output (8 ohm 5 watt , compatible with 8 ohm 10 watt dual-channel audio amplifier output)
Microphone	Support differential MIC input
Touchscreen	Support USB multi-point infrared touch, multi-point capacitive touch, multi-point nano film touch, multi-point acoustic wave touch, multi-point optical touch, etc.
RTC	Built-in real-time clock function
USB	1-way USB 3.0 HOST, 1-way USB 3.0 OTG, 3 -way expansion USB port
Infrared	Infrared receiver, supports infrared remote control function
Led	1*power status LED (green), 1*system LED (green, flashing by default)
Button	1*Upgrade key



CD COMMERCIAL DISPLAYS

Technical Specifications

Software Specifications	
Operating system	Android 14.0
Audio	MP3, WAV, APE, FLAC, OGG, M4A, 3GPP and other formats
Video	Support H.265, H.264, VP9, AVS2, AV1 and other video formats
Image	Support various image formats such as JPG, BMP, PNG, etc.
System comes with application software	APK Installer, Email, Calculator, Browser, Recorder, Calendar, Settings, Clock, Video Player, Search, Contacts, Gallery, Download, Camera, Music, Explorer, etc.
Language	Support multiple languages
Input	Standard Android keyboard, optional third-party input method
System Management	Native Android system, open root permissions, and can be used for product customization and development
	Real-time remote monitoring, self-recovery in case of system crash, 24/7 unattended operation
	Support OTA remote upgrade; support USB flash drive upgrade
	Support boot animation definition
	Support server/stand-alone mode switching
	Support Wi-Fi hotspot